



KT-WPLED55-M1-8CSB-VDIM

TRADITIONAL 55W NON-CUTOFF LED WALL PACK

DESCRIPTION

Traditional 55W Non-Cutoff LED Wall Pack | 120–277V Input | 3000–5000K | Medium-Size Bronze Housing | Glass Lens

APPLICATION

Building Mount for exterior illumination (perimeters, pathways, loading docks, and other general security lighting requirements)



PRODUCT FEATURES

- Traditional design matches appearance and light distribution pattern of legacy HID, optimized for one-for-one replacements
- Heavy-duty, die-cast aluminum housing with (5) available 1/2" threaded conduit hubs: (1) on back and (1) on all four sides
- Powered by Keystone 0–10V dimming LED drivers
- Keystone Color Select Technology: Adjustable CCT (3000K, 4000K, or 5000K)
- Built-in dusk-to-dawn photocell behind translucent 3/4" threaded plug with anti-yellowing agent
- Borosilicate glass lens diffuses light source and provides uniform distribution
- Covers footprint of mid-size HID wallpacks
- Ambient operating temperature: –40°C/–40°F to 50°C/122°F
- UL listed for wet locations, IP65
- 0–10V dimming, 10% min
- Power Factor: >0.95
- THD: <20%
- LED chip lifetime: L70 >100,000 hrs @ 25°C/77°F ambient fixture temp
- Meets FCC Part 15, Part B, Class A standards for conducted and radiated emissions
- Fixture impact rating IK06
- Compatible with Keystone LED Emergency Backups

ELECTRICAL SPECIFICATIONS

Catalog Number	Wattage	Lumens	Lumens Below 90°	Dimming	CCT*	Efficacy	CRI	Housing Color	Input Voltage	Rated Life	Legacy Equivalent
KT-WPLED55-M1-8CSB-VDIM	55W	7200 lm	6480 lm	0–10V	3000K	131 lm/W	>80	Bronze	120–277V	50,000 hrs	175–250W MH
		7690 lm	6895 lm		4000K	140 lm/W					
		7450 lm	6705 lm		5000K	135 lm/W					

* Color Uniformity: CCT (Correlated Color Temperature) range as per guidelines outlined in ANSI C78.377-2017



KT-WPLED55-M1-8CSB-VDIM

TRADITIONAL 55W NON-CUTOFF LED WALL PACK

PHOTOMETRIC SPECIFICATIONS

ISOCANDELA PLOT

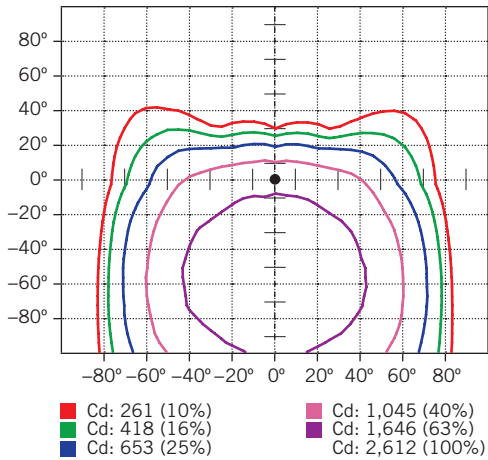

LUMINOUS INTENSITY DISTRIBUTION

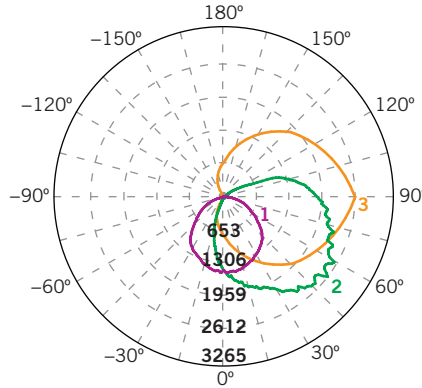

Average diffuse angle (50%): **109.9°**

Unit: cd

FLUX DISTRIBUTION

Zone	Lumens	% Luminaire
Forward Light	6,006 lm	81.9%
0°-30°	734 lm	10.0%
30°-60°	2,633 lm	35.9%
60°-80°	1,981 lm	27.0%
80°-90°	658 lm	9.0%
Back Light	629 lm	8.6%
0°-30°	241 lm	3.3%
30°-60°	294 lm	4.0%
60°-80°	80 lm	1.1%
80°-90°	15 lm	0.2%
Up Light	691 lm	9.5%
90°-100°	313 lm	4.3%
100°-180°	378 lm	5.2%

BUG* Rating

Asymmetrical Luminaire Types	
Type I, II, III, IV	B1 U3 G4
Quadrilateral Symmetrical Luminaire Types	
Type V, Area Light	B1 U3 G4

* Backlight, Uplight, Glare

MOUNTING

Side view

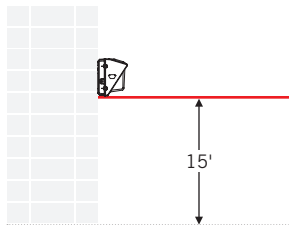

LIGHT DISTRIBUTION PATTERN

Isometric view from above; Luminaire mounted at 15'

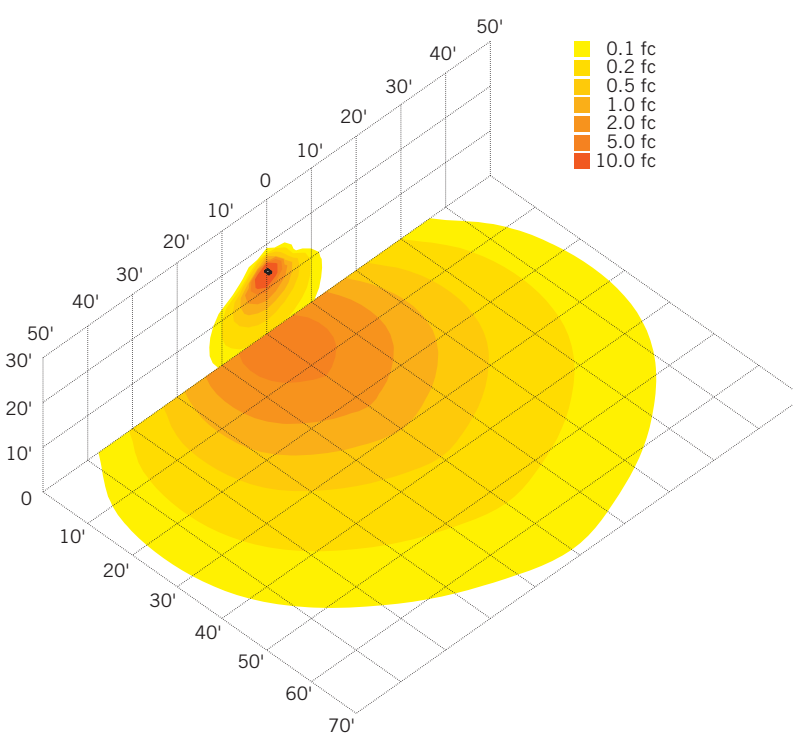



KT-WPLED55-M1-8CSB-VDIM

TRADITIONAL 55W NON-CUTOFF LED WALL PACK

PHYSICAL SPECIFICATIONS

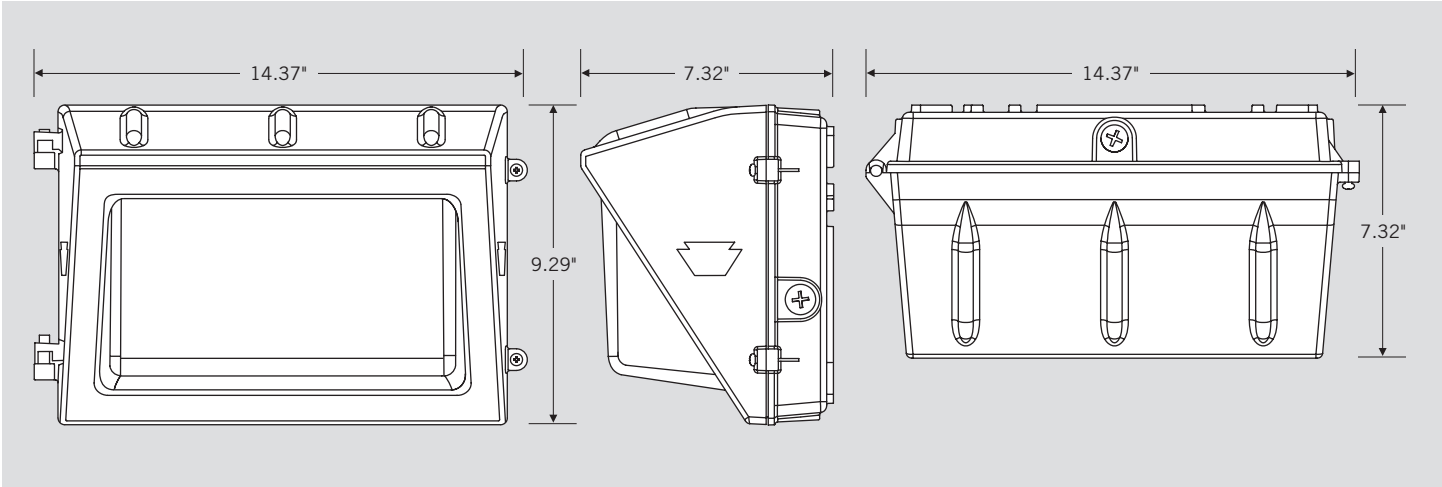

GENERAL SETUP INSTRUCTIONS

GENERAL WIRING DIAGRAM

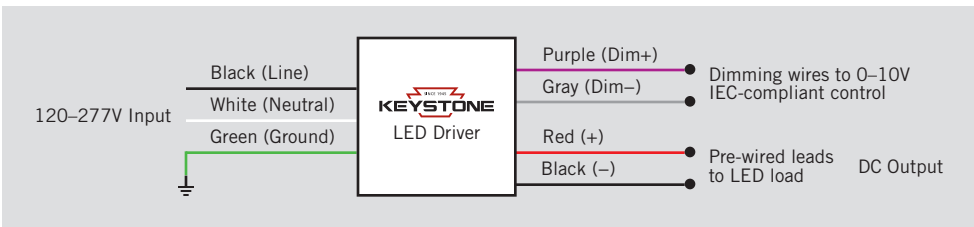

Caution: Before installing, make certain that AC power to the fixture is off.

Caution: The electrical rating of this product is 120-277V. Installer must confirm that there is 120-277V at the fixture before installation.

PHOTOCELL ENABLE/DISABLE

This fixture is equipped with a dusk-to-dawn photocell behind the translucent knock-out (KO) cover. Adjust the dip switch to enable (ON) or disable (OFF) the photocell function (see illustrations to the right). Fixture comes preset with photocell enabled unless otherwise noted.

COLOR SELECT (CCT) ADJUSTMENT

This fixture is equipped with Color Select technology. There is an adjustable dip switch behind the translucent knock-out (KO) cover to change CCT between 5000K, 4000K, and 3000K (see illustrations to the right). Fixture comes preset at 5000K unless otherwise noted.

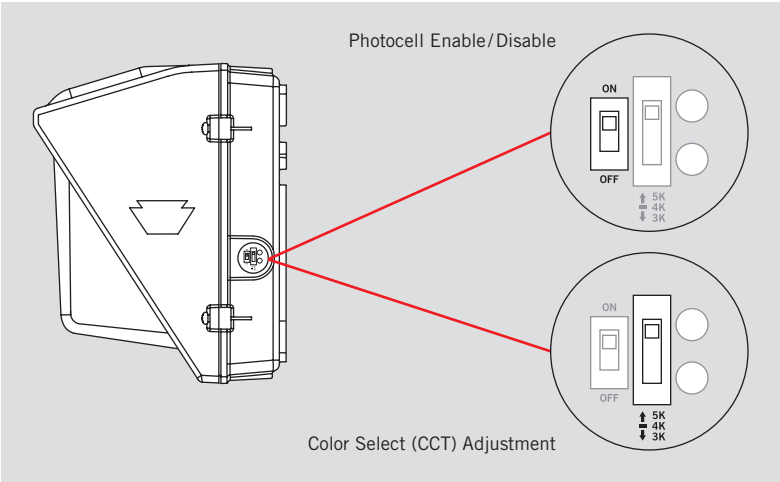



KT-WPLED55-M1-8CSB-VDIM

TRADITIONAL 55W NON-CUTOFF LED WALL PACK

ACCESSORY (SOLD SEPARATELY)

Catalog Number	Description
KTSP-10KV-C	Wallpack 10kV Surge Protector, Compact Design

ORDERING INFORMATION

CATALOG NUMBER	PACK QTY.	EASY CODE	UPC
KT-WPLED55-M1-8CSB-VDIM	1	BYJ-72	843654129020

CATALOG NUMBER BREAKDOWN

KT-WPLED55-M1-8CSB-VDIM

1	2	3	4	5	6	7	8	9	10	11
1 Keystone Technologies	2 Fixture Type	3 LED Lamp	4 Max Wattage	5 Size	6 Style	7 CRI	8 Color	9 Color Select Designation	10 Dimming	11 Additional Options
	F Flood WP Wallpack			S Small M Medium L Large	1 Non-Cutoff 2 Full-Cutoff	8 >80 9 >90	40 4000K 50 5000K CS Color Select	A 3500K, 4000K, 5000K B 3000K, 4000K, 5000K C 3000K, 3500K, 4000K, 5000K D TBD	VDIM 0-10V	No option /MW Microwave occupancy Sensor Installed /EMRG-12 12W Emergency Battery Backup Installed